

PD40-7

DIGGA

DIGGA

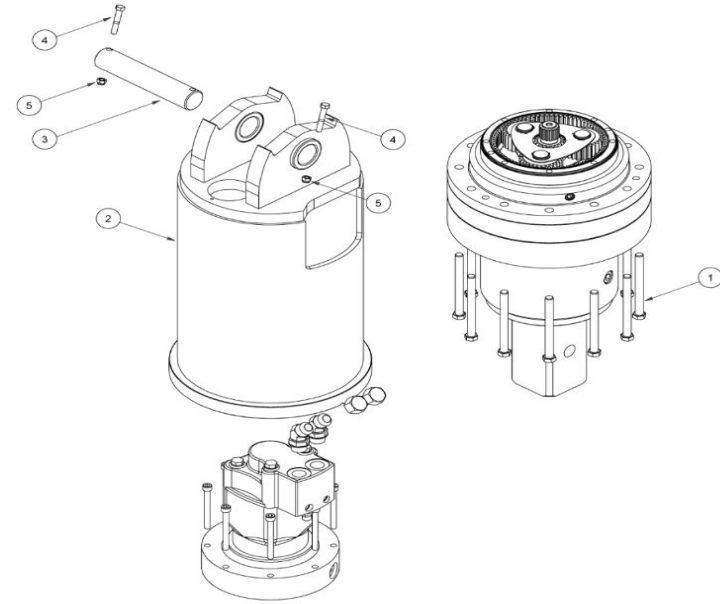
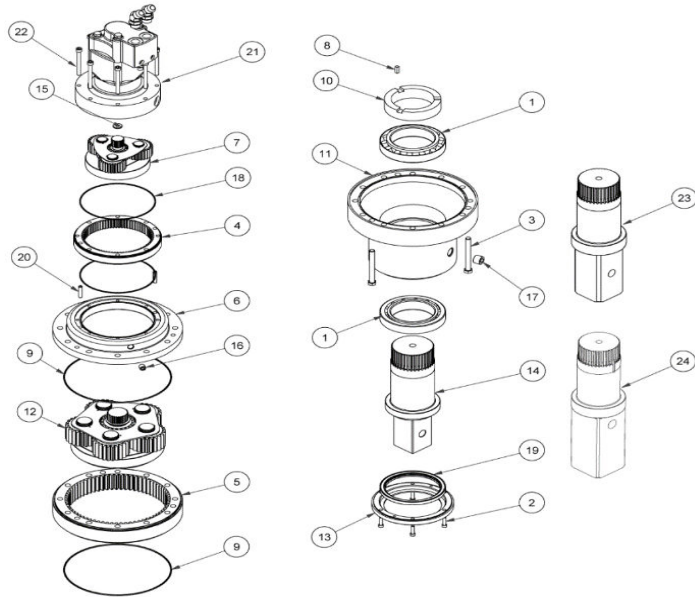

Part no	Description
1	BE-00029 BEARING
2	FA-000144 BOLT
3	FA-000184 BOLT
4	GB-000008 RING GEAR
5	GB-000539 RING GEAR
6	GB-000574 INTERIM HOUSING
7	GB-001432 GEARSET
8	GB-001467 KEY STEEL
9	GB-001469 O-RING
10	GB-001697 LOCK NUT
11	GB-001753 OUTPUT HOUSING
12	GB-001937 GEARSET
13	GB-001941 SEAL PROTECTOR
14	GB-002056 100MM SQUARE SHAFT
15	GB-002819 GEARBOX MOTOR SPACER
16	PP-000001 PRESSURE PLUG
17	PP-000003 PRESSURE PLUG
18	SE-000013 O-RING
19	SE-000039 SEAL
20	SP-000006 SPRING
21	MO-000555-3500 HYDRAULIC MOTOR
22	FA-000434 SOCKET SCREW

Part no	Description
1	FA-000081 BOLT
2	HO-000860 DRIVE UNIT HOOD
3	PI-000045 PIN
4	FA-000202 BOLT
5	FA-000093 NYLOC NUT